

# Determination of Hygrothermal Properties for Building Materials using Inverse Modeling Techniques

Jos van Schijndel and Sander Uittenbosch  
Eindhoven University of Technology, Netherlands

**Abstract:** The paper presents the development of a method that determines building material and surface properties using relative simple and low-budget experiments, with the following conditions: (I) Constrained: the material is located in building constructions and only non destructive measurements are allowed. (II) Unconstrained: the material is freely available for optimal testing. The latter comprehends an optimal design of an experimental set up for smart determination of heat and moisture properties using both normal and inverse modeling techniques. The preliminary results show that the inverse modeling method using MatLab is almost perfectly capable of reproducing the material parameters using the 3D Comsol simulations as input. However, using the actual measurements as input for the inverse modeling provides unsatisfactory results so far. It is concluded that the suggested methodology of the inverse problem technique seems promising for estimating material properties but requires that: (1) All measurements errors must be known; (2) The (measured) signals itself should deliver enough input power into the system; (3) The simulated objective data should be sensitive enough for changes in material properties.

**Keywords:** inverse modeling, building, material, moisture, thermal properties

## 1. Introduction

There are a lot of experiments available for the determination of heat and moisture related properties of building materials. For heat related properties of building materials, there are (very limited) methods to determine its properties of real buildings in situ. However, for moisture related properties of building materials, there are only a few methods available for the non-destructive determination at real buildings in situ. The latter is very relevant especially for monumental buildings, where it is not allowed to damage to building construction. The application and validity of some inverse modeling approaches related with this topic are well documented: Cardiff & Kitanidis (2008) present several 'inverse' problems such as those that occur in hydrology and geophysics are solved using partial differential equation

(PDE)-based models of the physical system in question. Their results indicate that our COMSOL-based routines provide an accurate, flexible, and scalable method for the solution of PDE-based inverse problems. Girault & Petit (2005) provide a method for solving nonlinear Inverse Heat Conduction Problems using a Reduced Model. A transient 3D example with thermal conductivity linearly dependant on temperature illustrates the method. Niliot & Lefevre (2004) deal with an inverse problem that consists of the identification of multiple line heat sources placed in a homogeneous domain. The proposed approach has been tested for steady and transient experiments. Using the techniques of parameter estimation, they can also estimate the confidence interval of the estimated locations, which permits to design an optimal experiment. Minasny & Field (2005) use inverse modeling to analyze the evaporation data facilitating the prediction of soil hydraulic properties. Their results show that the used methodology can provide the estimates of the hydraulic properties and along with its uncertainty. Dantas et al. (2003) deal with the solution of an inverse problem of parameter estimation involving heat and mass transfer in capillary porous media. The physical problem under picture involves the drying of a moist porous one-dimensional medium. Their main objective was to simultaneously estimate the dimensionless parameters appearing in the formulation of the physical problem by using transient temperature and moisture content measurements taken inside the medium.

The key objective is the development of a method that determines building material and surface properties using relative simple and low-budget experiments, with the following conditions: (I) Constrained: the material is located in historic building constructions and only non destructive measurements are allowed. (II) Unconstrained: the material is freely available for optimal testing. The latter comprehends an optimal design of an experimental set up for smart determination of heat and moisture properties using both normal and inverse modeling techniques. The methodology was: First, a design of an experimental set up for smart determination of only heat related material and surface

properties. Second, simulation of the sensors output by the modeling of 3D experimental set ups. Third, inverse modeling of the material and surface properties and evaluation of the uniqueness of the solution using simulated sensor data. The paper is organized as follows. Section 2 presents the smart determination of free available building materials using a simple test box. Section 3 shows a similar constrained method for real building constructions in situ. Finally, Section 4 provides a discussion of the results.

## 2. Unconstrained determination

In order to determine material properties using inverse modeling techniques, measurements are needed as input signals. A sample (brick) along a small a cavity is surrounded by insulation. It is designed to have a dominant heat flow in one direction through the sample. In Figure 1, the experimental box is shown. Four NTC resistors measure the following temperatures: (1) The outside temperature  $T_e$ ; (2) the outside surface of the sample (brick)  $T_{eA}$ ; (3) the surface of the brick at the inside  $T_{iA}$  and (4) the air temperature inside the cavity ( $T_i$ ). The solar irradiation is also measured.

The final goal is to determine material characteristics from measured indoor, outdoor and surface conditions. In order to research the feasibility of the method we started by determining these characteristics using COMSOL (2010) simulations. We created 3D computational models using standard the modules 'convection and conduction' for the temperature and 'incompressible Navier-Stokes' for the air movement in the cavity The following material properties of air: the density and dynamic viscosity are depended of the (air) temperature. The boundary conditions of the volume of air inside the construction are no slip wall conditions. The thermal boundary conditions of the construction are defined as inward heat fluxes. Figure 2 shows some exemplarily simulation results. All results are obtained using default meshing en solver settings.

The sample material (brick) of the experimental box is modelled using ODES in MatLab. In this study  $T_i$  (Internal Temperature),  $T_{iA}$  (Internal Surface Temperature),  $T_{eA}$  (External Surface Temperature) and the  $T_e$  (External Temperature) are measured.. The heat flow through the brick can be approximated as an RC analog shown in Figure 3.

MatLab is used for determination of material properties of the sample by using inverse modeling. The principle of inverse modeling is shown schematically in Figure 4. The parameters  $T_i$ ,  $T_{eA}$  and  $T_e$  are input signals for the ODE model, as shown above. Initial guesses are made for respectively the thermal conductivity ( $k$ ), density of the sample ( $\rho$ ) and the heat capacity ( $c$ ). Using these first estimates, we simulate the  $T_{iA}$  dynamically. The simulated  $T_{iA}$  will be compared with the measured  $T_{iA}$ . The sum of the absolute value of the difference of these two results ('error') is calculated. For decreasing the error an adaption of the estimate of the thermal conductivity, density and the heat capacity is needed. A standard optimization routine in MatLab is used to produce new estimates of the material properties that minimizes the error. In this case, i.e. the simulated  $T_{iA}$  is optimal correlated with the measured  $T_{iA}$ , the material properties are compared with the reference material properties. The preliminary results show that the inverse modeling method using MatLab is almost perfectly capable of reproducing the material parameters using the 3D Comsol simulations as input (see Figure bottom right). The fitted values are also shown in Table I:

	MatLab Inverse model	Comsol reference value
k	0,999	1
rho_c	1008500	1008000

The above mentioned method is also applicable using the actual measurements (see Figure 1) as input for the inverse modeling. In this case, measurement errors can become of great importance. Currently we are still working with the measured data. The final outcome of the accuracy of this determination of the inverse modeling is therefore at the moment of publication of this paper unfortunately unknown.

## 3. Constrained determination

The data set is part of the measurement program at the Hunting Lodge St. Hubertus site performed during 2006-2007. Details of this project can be found in Briggen et al (2009). One of problems seemed to be high moisture contents at the inside surface of the façade of the tower. The construction of this façade is shown in Figure 5. The outside climate conditions were measured by a weather station within 50m from the building.

The inside air temperature and relative humidity were measured using standard equipment. A representation of inside surface conditions were obtained by placing a small box (5cm x 5cm x 1cm) against the wall and measure the air temperature and relative humidity inside (see Figure 5). The estimation of the measurement error of this method is left over for future research. The *input* data consists of the measured time series of the indoor and outdoor climate as presented in Figure 6.

A model capable of simulating the requested data is required. Amongst other possibilities, the Multiphysics modeling approach of van Schijndel (2007) is selected. A guideline on how to implement up to 3D heat air and moisture (HAM) transport models using COMSOL (2008) is already provided (van Schijndel 2006). There are two major extensions to this work, described in this section: First, the implementation of LPc as moisture potential for including both vapour and liquid transport and second, the implementation of material and boundary functions for calculating the PDE coefficients from the material properties. The implementation of the two new extensions is verified using the HAMStad benchmark 1 (Hagentoft et al 2002) and published in (van Schijndel 2008). The model is summarized now. The heat and moisture transport can be described by the following PDEs:

$$C_T \frac{\partial T}{\partial t} = \nabla \cdot (K_{11} \nabla T + K_{12} \nabla LPc)$$

$$C_{LPc} \frac{\partial LPc}{\partial t} = \nabla \cdot (K_{21} \nabla T + K_{22} \nabla LPc)$$

With

$$LPc = {}^{10} \log(Pc)$$

$$C_T = \rho \cdot c$$

$$K_{11} = \lambda$$

$$K_{12} = -l_{iv} \cdot \delta_p \cdot \phi \cdot \frac{\partial Pc}{\partial LPc} \cdot P_{sat} \cdot \frac{M_w}{\rho_a RT},$$

$$C_{LPc} = \frac{\partial w}{\partial Pc} \cdot \frac{\partial Pc}{\partial LPc}$$

$$K_{22} = -K \cdot \frac{\partial Pc}{\partial LPc} - \delta_p \cdot \phi \cdot \frac{\partial Pc}{\partial LPc} \cdot P_{sat} \cdot \frac{M_w}{\rho_a RT},$$

$$K_{21} = \delta_p \cdot \phi \cdot \frac{\partial P_{sat}}{\partial T},$$

Where t is time [s]; T is temperature [°C]; P<sub>c</sub> is capillary pressure [Pa]; ρ is material density [kg/m<sup>3</sup>]; c is specific heat capacity [J/kgK]; λ is thermal conductivity [W/mK]; l<sub>iv</sub> is specific latent heat of evaporation [J/kg]; δ<sub>p</sub> vapour permeability [s]; φ is relative humidity [-]; P<sub>sat</sub> is saturation pressure [Pa]; M<sub>w</sub> = 0.018 [kg/mol]; R = 8.314 [J/molK]; ρ<sub>a</sub> is air density [kg/m<sup>3</sup>]; w is moisture content [kg/m<sup>3</sup>]; K is liquid water permeability [s].

The material database of DELPHIN (2010) is used to provide material properties for the first guess. For brick, the Brick material properties of DELPHIN are used with constant ρ= 1700; c = 840; λ = 0.85 and variable moisture properties using the tables. For concrete, the Lime plaster properties of DELPHIN (ρ= 1800; c = 840; λ = 1.05) are used in the same way. From these data, the PDE coefficients were determined, see Figure 7. Together with the boundary conditions implemented using the COMSOL model of Section 3.2. Figure 8 shows that the simulated inside surface temperature is already quite close to the measured one. At this point it is very important to consider possible errors (due to measurement methodology) of the objective data.

The main questions are: First, what is uncertainty band of the measured inside temperature? Second, is it possible simulated the inside temperature inside the uncertainty band by manipulating PDE and boundary coefficients? The simulated relative humidity at the inside surface of Figure 8 seems to be less close to the measured one compared to the previous figure. This gives also rise to the just mentioned questions. As a first step towards a full model parameter optimisation, the dependency of simulated indoor surfaced temperature to the PDE coefficients (including the boundaries) was investigated. The outcome was that it the simulated indoor surface conditions seem to be quite insensitive for the PDE coefficients and surface coefficients. Moreover, the low sensitivities (temperature ~ 0.2 °C and relative humidity ~ 1%) close to the expected (stochastic) measurement error. This could mean that the methodology is not applicable for this type of building construction.

#### 4. Discussion and Conclusions

*Unconstrained determination* - The preliminary results show that the inverse

modeling method using MatLab is almost perfectly capable of reproducing the material parameters using the 3D Comsol simulations as input. However, using the actual measurements (see Figure 1) as input for the inverse modeling provides unsatisfactory results so far. After closer inspection unexpected air infiltration might be the cause. This will be fixed in the near future

*Constrained determination* - It is quite clear that there are still major problems to be solved before the suggested methodology of the inverse problem technique will be useful for estimating material properties. Before going into the drawbacks of the approach, the reader should notice that the major benefit, in case of a successful method, could be that material properties are very easy obtained in situ and without damaging the construction by quite simple measurements. However, this is clearly not the case yet due to the following limitations: (1) All measurements errors must be known. For example, in this case sensors are placed in a small box attached to the inside wall (see Figure 5). This means that there is also a systematic error in measuring the inside surface conditions. (2) The (measured) signals itself should deliver enough input power into the system. For example in this research, the rain intensity has a relative high Crest factor due to the less than 10 rain events in one month. (3) The simulated objective data (in this case inside surface conditions) should be sensitive enough for changes in material properties. For example in this case the heat conduction coefficients of both materials were simultaneously doubled or halved and the results were compared. The result was only a minor effect. The effect seems to be too low for obtaining reliable material properties.

It is recommended, in case of applying inverse problem techniques, to simulate the sensitivity of the objective data on the material properties before starting measurements. Furthermore, if this simulated sensitivity is promising, the measurement error should be an order lower than the sensitivity.

## References

Briggen, P.M., Blocken, B.J.E., Schijndel, A.W.M. van, Schellen, H.L. (2009). Wind-driven rain and related moisture problems at the tower of a monumental building. Proc. of the 4th International Building Physics Conference (IBPC), 15-18 June 2009, Istanbul, Turkey. pp. 709-716

Cardiff Michael, Peter K. Kitanidis (2008), Efficient solution of nonlinear, underdetermined inverse problems with a generalized PDE model. Computers & Geosciences, 34(11), 1480-1491

Dantas, L.B., H. R. B. Orlande, R. M. Cotta (2003), An inverse problem of parameter estimation for heat and mass transfer in capillary porous media. International Journal of Heat and Mass Transfer, 46(9), 1587-1598

COMSOL 2010 , <http://en.wikipedia.org/wiki/COMSOL>

DELPHIN 2010, [http://de.wikipedia.org/wiki/Delphin\\_\(Software\)](http://de.wikipedia.org/wiki/Delphin_(Software))

Girault Manuel, Daniel Petit (2005), Identification methods in nonlinear heat conduction. Part II: inverse problem using a reduced model. International Journal of Heat and Mass Transfer, 48 (1), 119-133

Hagentoft, C-E. et al, 2002a, HAMSTAD WP2 Modelling, Version 4. Report R-02:9. Gothenburg: Chalmers University of Technology

Hagentoft, C-E et al , 2002b, Final report: Methodology of HAM-Modelling. Report R-02:8. Gothenburg: Chalmers University of Technology

HAMLab 2010 , <http://sts.bwk.tue.nl/hamlab/>

Minasny Budiman, Damien J. Field (2005), Estimating soil hydraulic properties and their uncertainty: the use of stochastic simulation in the inverse modelling of the evaporation method. Geoderma, 26(3-4), Pages 277-290

Le Niliot Christophe, Frédéric Lefèvre (2004), A parameter estimation approach to solve the inverse problem of point heat sources identification. International Journal of Heat and Mass Transfer, 47(4), 827-841

Schijndel A.W.M. van (2006), Heat, Air and Moisture Construction modeling using COMSOL with MatLab, Modeling guide version 1.0, Proceedings of the COMSOL Users Conference 2006 Eindhoven

Schijndel A.W.M. van (2007), Integrated Heat Air and Moisture Modeling and Simulation, Bouwstenen 116, ISBN: 90-6814-604-1, Eindhoven University of Technology

Schijndel, A.W.M. van (2008). Guidelines for Heat and Moisture Modeling in Constructions Using Mutliphysics FEM Software. Building Physics Symposium Leuven. (pp. 59-62).

Figures and Tables:

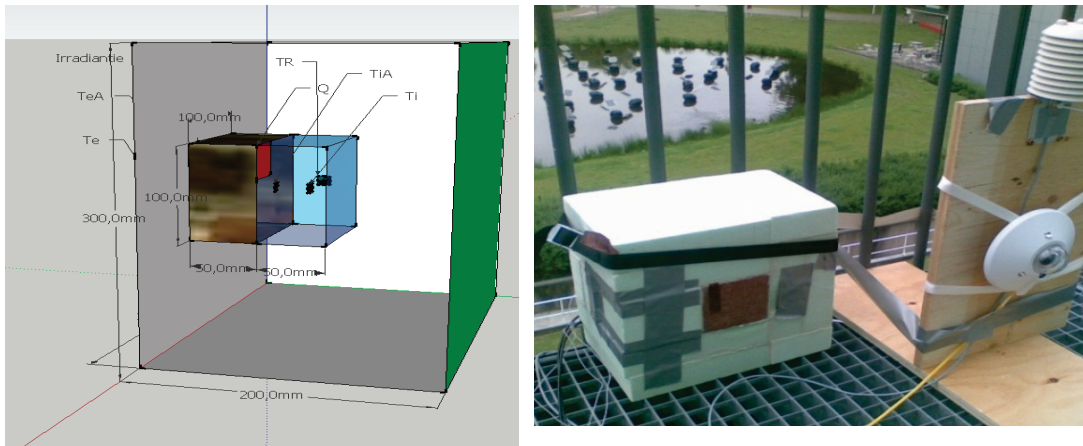

FIG 1. The experimental box. Top Left: The design; Top Right: The box placed outside,

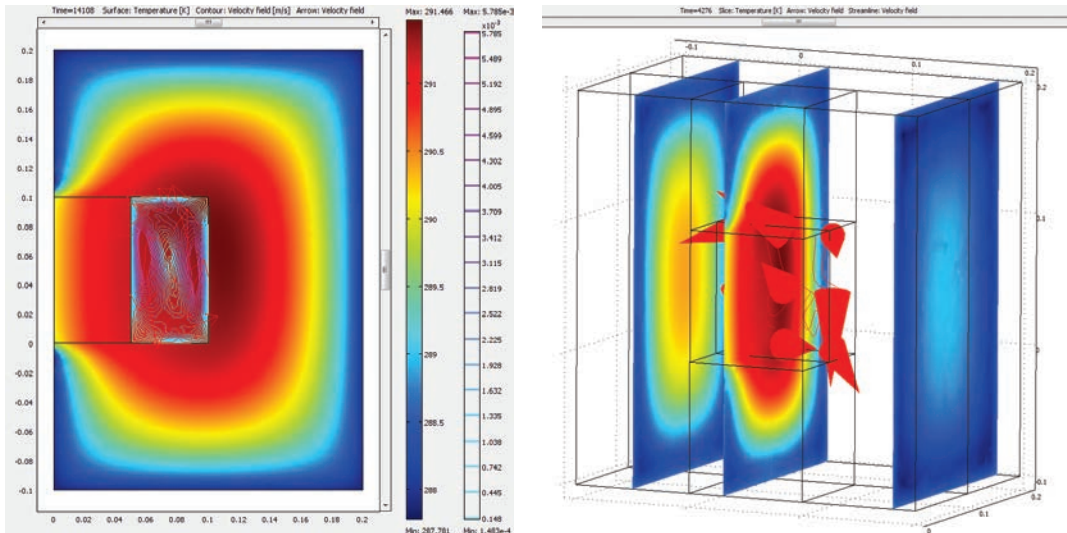

FIG 2. The simulation of the experimental box. Left: Slice at the centre of the box, showing temperatures and air velocities. Right: Similar for 3D

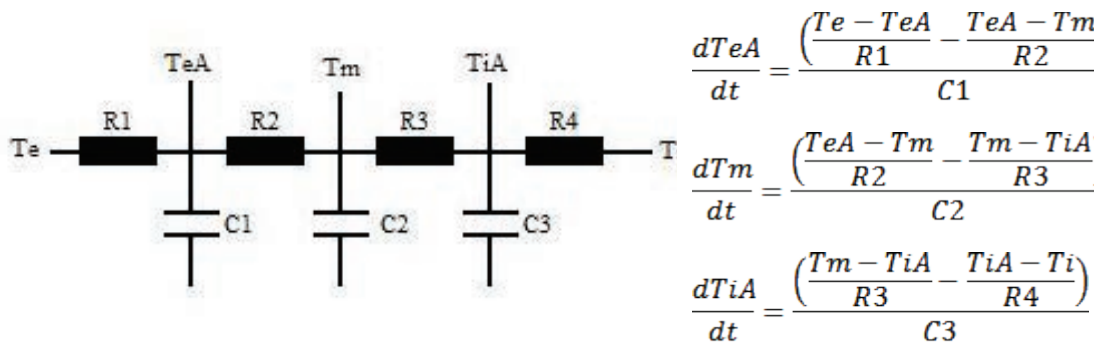

FIG 3. The ODE model of the sample material. Left: The RC analog; Right: The ODEs

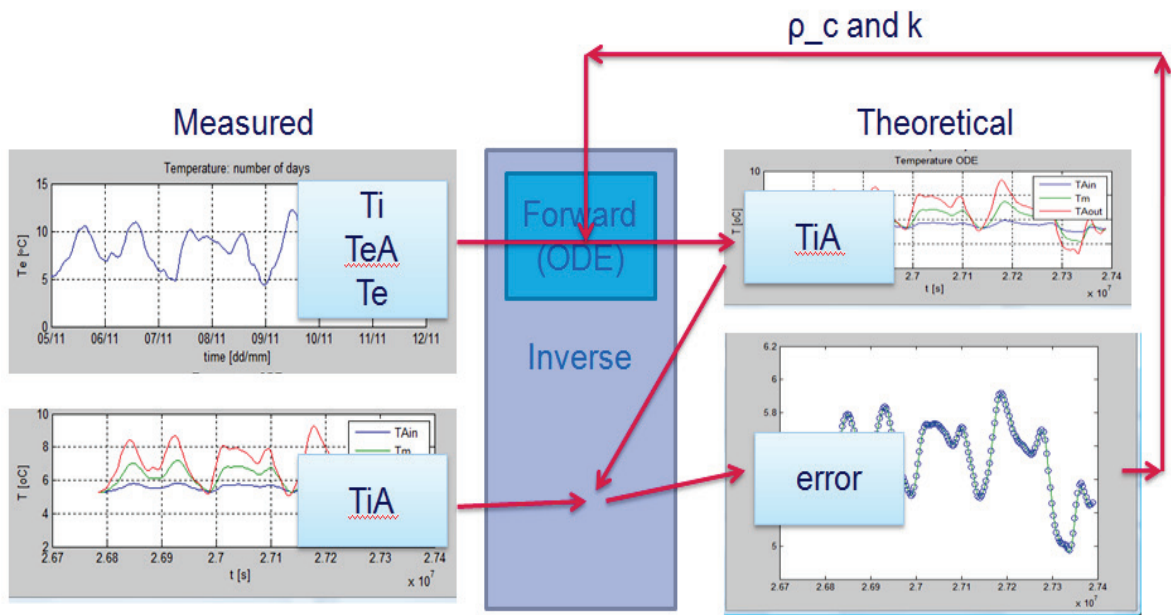

FIG 4. Schematic representation of the inverse modeling. The bottom right graph shows the reference temperature of Comsol (blue o) and the final result of the MatLab inverse model (green -.)

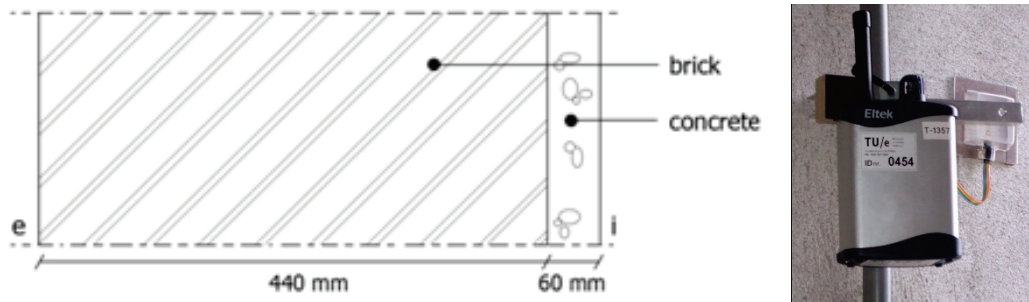

FIG 5. The building façade (left) and measurement equipment (right)

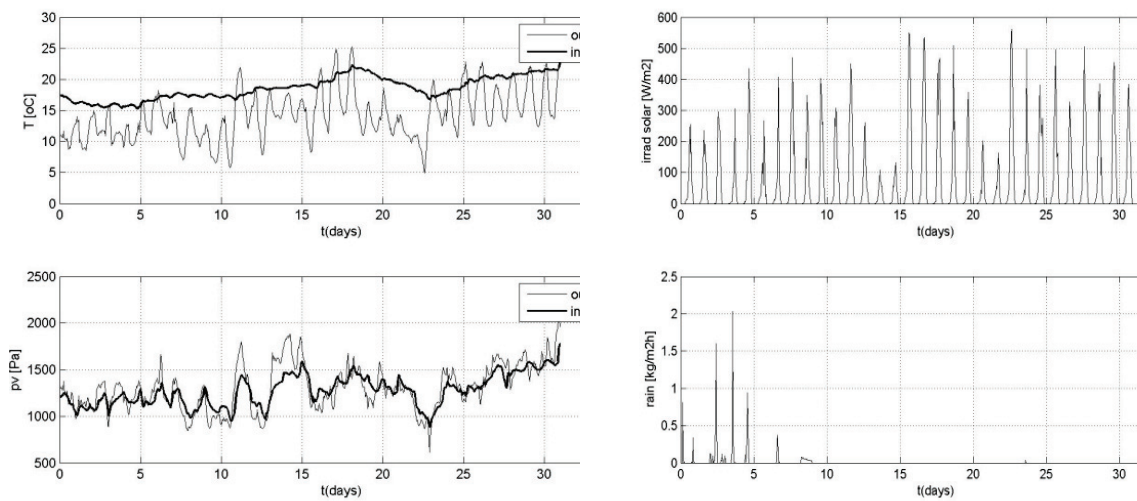

FIG 6. The measured input signals for the model. Top Left: Air temperature; Top Right: Solar irradiance, Bottom Left: Vapour pressure; Bottom Right: Rain intensity

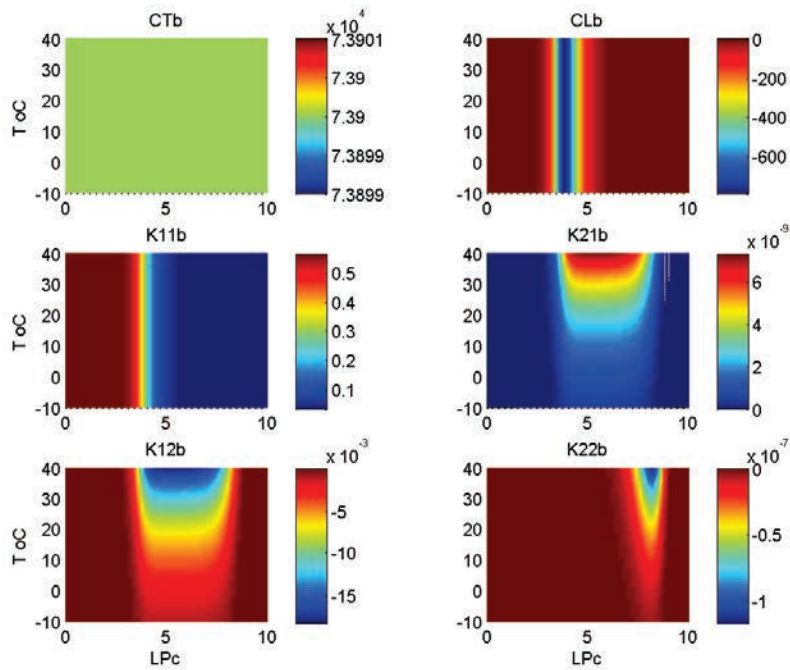

FIG 7. PDE coefficients  $C_T, C_{LPc}, K_{ij}$  as functions of  $LPc$  and  $T$  calculated using the material database of DELPHIN (2010)

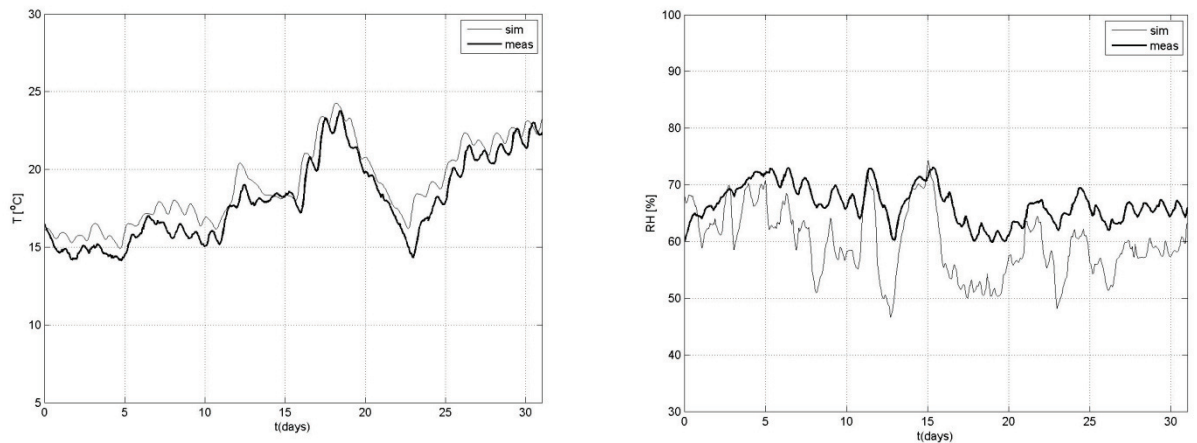

FIG 8. The measured and simulated inside surface temperature (left) and relative humidity (right).